



User-Service Manual

Joerns® Bed Frames

Model Bari10A

To avoid injury, read user's manual before using.



Important Precautions

- ⚠ **Warning: Possible Injury Or Death.** This product is intended for use as an adjustable mattress support platform that contours for resident/patient comfort with adjustable height for resident/patient and caregiver convenience. Use of this product in a manner for which it was not designed could result in unproven or unsafe configuration, potentially resulting in injury or death.
- ⚠ **Warning: Possible Injury.** Before adjusting bed, ensure that area under and near bed perimeter is free of people and obstructions. Failure to do so could result in injury.
- ⚠ **Warning: Possible Injury.** Keep bed in lowest position except when providing care (bathing, clothing changes, etc.). Bed should be at lowest convenient height for entry or exit. Failure to do so could result in injury.
- ⚠ **Warning: Possible Injury Or Death.** Floor locks increase bed stability and resident/patient safety. Floor and caster swivel locks must be locked prior to any resident/patient transfer or resident/patient use of the bed. Failure to do so could result in injury or death.
- ⚠ **Warning: Possible Injury Or Death.** Residents/patients may become entangled in pendant cord. Patients with reduced mental acuity should not be allowed access to pendant. Unsupervised use of pendant could result in injury or death.
- ⚠ **Warning: Possible Injury Or Death.** Bed safe working load is 1050 pounds. This is total weight counting resident/patient, mattress, bedding and any other equipment or persons likely to be on bed. Do not exceed 1050-pound safe working load. Exceeding the safe working load could result in property damage, injury or death.
- ⚠ **Warning: Possible Fire Hazard.** Use nasal mask or ½ bed tent oxygen administering equipment. Oxygen tent should not extend below mattress support platform. Pendant should not be placed in an oxygen-enriched environment such as an oxygen tent. Use of electrical circuits in an oxygen-enriched environment could result in a fire hazard.
- ⚠ **Warning: Possible Shock Hazard.** Unplug power cord from wall outlet before performing any maintenance, cleaning, or service to the bed. Failure to do so could result in injury or death. **Note:** In case of unexpected movement, disconnect battery and unplug bed from any outlet.
- ⚠ **Warning: Possible Shock Hazard.** Injury may result from improper routing of the power cord. Always follow the proper factory-installed routing configuration. Failure to do so could result in injury or death.
- ⚠ **Warning: Possible Injury Or Death.** Use a mattress that is properly sized to fit mattress support platform, which will remain centered on mattress support platform relative to State and Federal guidelines. Length and width should match mattress support platform. Use of an improperly fitted mattress could result in injury or death.
- ⚠ **Warning: Possible Injury Or Death.** If a resident/patient's mental or physical condition could lead to resident/patient entrapment, the mattress support platform should be left in the flat position when unattended. Failure to do so could result in injury or death.
- ⚠ **Warning: Possible Injury or Death.** An optimal bed system assessment should be conducted on each resident by a qualified clinician or medical provider to ensure maximum safety of the resident. The assessment should be conducted within the context of, and in compliance with, the state and federal guidelines related to the use of restraints and bed system entrapment guidance, including the Clinical Guidance for the Assessment and Implementation of Side Rails published by the Hospital Bed Safety Workgroup of the U.S. Food and Drug Administration. Further information can be obtained at the following web address: <http://www.fda.gov/MedicalDevices/ProductsandMedicalProcedures/GeneralHospitalDevicesandSupplies/HospitalBeds/default.htm>.
- ⚠ **Warning: Possible Injury Or Death.** Use a properly sized mattress in order to minimize the gap between the side of mattress and Side Rails/Assist Devices. This gap must be small enough to prevent resident/patient from getting his/her head or neck caught in this location. Make sure that raising or lowering bed, or contouring the mattress support platform, does not create any hazardous gaps. Excessive gaps may result in injury or death.
- ⚠ **Warning: Possible Injury Or Death.** Do not use any Side Rails/Assist Devices until you verify they are locked in place. Failure to lock assist devices may result in injury or death.
- ⚠ **Warning: Possible Injury Or Death.** Do not use any replacement parts not manufactured, marketed, or provided by Joerns Healthcare on any Joerns bed. Use of unapproved replacement parts may result in injury or death.

⚠ Warning: Possible Injury Or Death. If using accessories not manufactured, marketed, or provided by Joerns Healthcare for Joerns® beds, consult with the manufacturer for compatibility and limitations prior to use. Failure to do so may result in injury or death.

⚠ Warning: Possible Shock Hazard. Bed power cord has hospital-grade, 3-pronged grounded plug. Grounding reliability can only be achieved when equipment is connected to an equivalent receptacle marked "hospital-grade". If external grounding conductor is in doubt, operate bed from backup battery. Failure to do so could result in injury.

⚠ Warning: Possible Equipment Damage Or Injury To Staff Members. Service and repair must only be performed by qualified, authorized Joerns Healthcare Technical Support personnel (call 800-966-6662).

⚠ Warning: Explosion Hazard. Do not use in the presence of flammable anesthetics, gas or vapors. Failure to heed this warning could result in equipment damage, injury or death.

⚠ Caution: Stay clear of underneath the bed when adjusting or moving the bed.

⚠ Caution: Mattress support platform is not grounded, nor does it have a potential equalization connection point. To prevent injury to resident/patient connected to intravascular or intercardial medical equipment, alternate measure must be implemented to equalize the potential between mattress support platform and medical equipment.

⚠ Warning: To reduce the risk of injury, ensure the mattress support platform is horizontal and in the lowest position with the siderails fully raised and locked when moving the bed with a resident/patient in it. For best maneuverability, push the bed from the head end.

To avoid injury to the resident/patient and/or user, do not attempt to move the bed laterally with the steer engaged. The wheel cannot swivel.

⚠ Warning: The Bari10A should not be used adjacent to, or stacked with, other equipment due to the risk of electronic interference. If adjacent or stacked use is necessary, the bed should be observed to verify normal operation in the configuration in which it will be used.

⚠ Warning: Using non-approved cables and accessories may negatively affect the EMC performance.

⚠ Warning: Mobile RF communication equipment can affect Medical Electrical Equipment.

⚠ Warning: Medical electrical equipment needs special precautions regarding EMC and needs to be installed and put into service according to the EMC information provided in this manual.

⚠ Caution: Particular precaution must be considered during exposure to strong emission source such as High Frequency surgical equipment and similar devices. Do not route High Frequency cables on or near device. If in doubt, contact a qualified technician.

⚠ Warning: Possible Injury or Death. Make sure mattress support platform is in non-extended position (narrow) and all casters are locked during resident/patient transfers.

⚠ Caution: To avoid damage to the siderail mechanisms, do not move the bed using the siderails. Use the push/pull handles integrated in the end panels to move the bed.

⚠ Caution: Before transporting bed, unplug bed from power source, wrap Power Cord around cord storage hooks on bed frame below Head Panel and hang Pendant from Head Panel. Failure to do so could result in Power Cord, pendant cord, or bed damage, thereby creating a potential hazard.

⚠ Caution: Drainage bag loops are not intended for use as tie downs.

Do not position the device where access to mains connection cannot be disconnected.

There are no known contraindications for this device.

This bed conforms to Application Environment 3 of IEC 60601-2-52.

When assessing the risk for entrapment, you need to consider your bed, mattress, Head/Foot Panels, Side Rails/Assist Device and other accessories, as a system. It is also extremely important to review the resident/patient's physical and mental condition and initiate an appropriate individual care plan to address entrapment risk. All Joerns bed systems are evaluated for compliance to the FDA/CDRH "Hospital Bed System Dimensional and Assessment Guidance to Reduce Entrapment." For more information, call Customer Care, 800-826-0270.

Save These Instructions

Table of Contents

Important Precautions	2
Entrapment Information	4
Features and Specifications	5
Assembly	6
Bed Operation	7
Accessories	11
Scale System.....	13
Cleaning, Inspection and Maintenance	16
Lubrication Servicing	17
Troubleshooting.....	18
Appendix Diagrams	20
Warranty	22

Thank you and congratulations for choosing the Joerns Bari10A bed. Joerns beds are developed with safety, comfort and convenience of both resident/patients and caregivers in mind.

Advanced ergonomic design will provide years of reliable service in your facility.

Bed System Entrapment Information

In April 1999, the U.S. Food and Drug Administration (FDA) in partnership with representatives from the hospital and post-acute bed industry, including Joerns Healthcare, national healthcare organizations, resident advocacy groups, and other federal agencies formed the Hospital Bed Safety Workgroup (HBSW). The workgroup's goal is to improve the safety of bed frames for patients and residents in all health care settings who are most vulnerable to the risk of entrapment. The efforts of the FDA and the HBSW culminated in the FDA's release of recommended guidelines intended to reduce the risk of entrapment, including dimensional limits for critical gaps and spaces between bed system components and clinical guidance for assessment and implementation of bed side rails in various health care settings.

Entrapment zones involve the relationship of bed components often directly assembled by the healthcare facility rather than the manufacturer. Therefore, compliance is the responsibility of the facility.

As the leading manufacturer of long-term care beds and a frontrunner in addressing this critical issue, Joerns Healthcare can offer you the expertise, assistance and products to bring your facility into compliance.

Joerns® Compliance Solutions

Matching the right bed components in order to meet regulatory guidelines can be complex.







That is why Joerns offers a wide array of compliance options. We assist customers in selecting compliant accessories recommended for their specific bed model.

For More Information

To learn more about compliance options with Joerns products, visit our website at www.joerns.com, or contact our Customer Care reps at 800-826-0270 and ask for free informational publications.

To learn more about entrapment zones, assessment methods, and guidelines concerning entrapment, contact Joerns Healthcare at 800-826-0270 or consult the FDA website: <http://www.fda.gov/MedicalDevices/ProductsandMedicalProcedures/GeneralHospitalDevicesandSupplies/HospitalBeds/default.htm>

I.D. Label Symbol Definition

	Attention/Warning
	Refer To Instruction Manual (Note: printed here in black, actual color blue)
	Refer To Instruction Manual
	Safe Working Load
	Type B Applied Parts, user controls, mattress, support platform
	Protective Earth (ground)

Features and Specifications

Joerns® Bari10A Standard Features

- Fully adjustable mattress support platform with independent back and knee movement, up/down adjustments, Trendelenburg and Reverse Trendelenburg positioning and Comfort Chair positioning
- 36" wide mattress support platform sections easily expand to 48" wide
- Mattress support platform expands from 80" to 88" length
- Height adjustable from 18¾" to 33¾"
- Side Rails on head and foot sections fold down for easy resident/patient access
- Pendant control for all bed functions
- Staff Control with lockouts and backlighting
- Emergency Manual Release for mattress support platform
- Emergency Battery Backup system
- Integrated Scale System for resident/patient weight monitoring
- Quiet DC Motors
- Welded steel tubular frame
- Pan-style mattress support platform
- Wide stable base
- SoftTone frame color
- Heavy-duty casters
- Bed and back section angle indicators
- Drainage bag loops
- IV Sockets (½" and ¾")

Electrical Specifications

Controller

Power: 115 VAC North American
Frequency: 60 Hz
Current Rating: 5.8 Amps
Classification: Class 1, Type B
Mode of Operation: 10% Maximum duty cycle
Circuit Protection: Auto reset current sensors
Note: Actuators operate on a 24V DC system with an integral battery backup.

Classifications

ANSI/AAMI ES 60601-1 : 2005, ed.3
CAN/CSA-C22.2 No. 60601-1 (2008), ed.3
IEC 60601-1 : 2005 + CORR. 1 (2006) + CORR.2 (2007), ed.3
IEC 60601-2-52, Edition 1.0, 2009-12

Environmental Conditions

Operating Conditions

Ambient Temperature: +20°C to +30°C
Relative Humidity: 10% to 95% Non-Condensing
Atmospheric Pressure: 700 hPa to 1060 hPa
Protected Against Splashing Water IPX4

Storage and Shipping Conditions

Ambient Temperature: -30°C to +50°C
Relative Humidity: 10% to 95% Non-Condensing
Atmospheric Pressure: 500 hPa to 1060 hPa

Accessories And Options

Joerns Therapeutic Support Surfaces, IV Rod, Floor Mat, Patient Helper, Steer Wheel, Dual Casters

Bed Identification Numbers

When ordering parts or when contacting our Customer Care Department, please include the bed's model and serial numbers, found on the identification label. The identification label is located on bed frame under the sleep deck foot section.

Mechanical Specifications

Description:	Dimensions:
Overall Bed.....	Minimum 39"x 90" Maximum 52"x 98"
Mattress Support Platform.....	Minimum 36"x 80" Maximum 48"x 88"
Bed Frame Weight.....	700 lbs
Maximum Back Section Angle	65° to horizontal
Maximum Knee Section Angle	35° to horizontal
Maximum Knee to Leg Angle.....	45°
Maximum Height Mattress Support Surface.....	33-3/4" Above Floor
Minimum Height Mattress Support Surface.....	18-3/4" Above Floor
Safe Working Load	1050 lbs

Assembly

Installation Of Head And Foot Panels

Notice: Make sure the power cord is unplugged from the power outlet and the control unit battery is removed prior to disconnecting/connecting any foot panel cables. Failure to ensure bed is not powered when disconnecting/connecting the foot panel cables may result in damage to the bed's electronic controls.

1. Confirm that the bed's power cord is not connected to the power outlet. Confirm that the control unit battery has not been installed.
2. Insert head and foot panel support rods into their respective receptacles in the frame (Figure 1).
3. Connect cables exiting the bottom of the foot panel to the appropriate cables on the bed frame (Figure 2).
4. Power cord supplies power to bed's actuator system. Plug power cord into grounded hospital-grade receptacle (115VAC, 15 amps).
Note: To achieve optimum battery life, keep the bed plugged in at all times.
5. Slide the battery onto the control unit until the retention clips snap into position. Confirm the battery is locked into place by trying to remove the battery without disengaging the retention clips.
6. Power cord is the main disconnect device. To disconnect the mains, unplug power cord. Backup battery powers the actuators when cord is unplugged.
7. Whenever bed is cleaned or serviced, it should be unplugged from wall power. The battery can still power the bed, so functions should be locked to keep bed from accidentally operating.
Note: To avoid electric shock, always plug bed into properly grounded hospital-grade receptacle.
8. Battery backup is **not** user-serviceable. If service is required, contact Joerns Healthcare Technical Support at 800-966-6662.



Figure 1

Head Panel Removal

1. Head panel easily removes by lifting straight up (Figure 1).
2. Head panel pins fit tightly in respective frame receptacles. This may cause binding during removal and replacement.
3. To minimize binding, grasp head panel at both lower corners and lift evenly.

Foot Panel Removal

Notice: Make sure the power cord is unplugged from the power outlet and the control unit battery is removed prior to disconnecting/connecting any foot panel cables. Failure to ensure bed is not powered when disconnecting/connecting the foot panel cables may result in damage to the bed's electronic controls.

1. Depress retention clips on back of the battery with one hand while slowly sliding the battery backward. **Note:** Support the weight of the battery.
2. Unplug the bed from the power outlet.
3. After disconnecting the battery and the power cord, briefly push any pendant or staff control button in order to de-energize the control system completely prior to disconnecting/connecting any other cables.
4. Disconnect foot panel cables (Figure 2).
5. Foot panel pins fit tightly in respective frame receptacles. This may cause binding during removal and replacement.
6. To minimize binding, grasp foot panel at both lower corners and lift evenly.

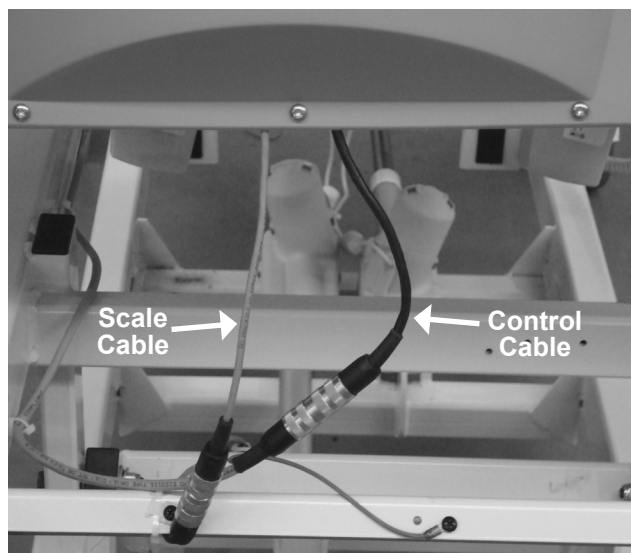

Figure 2
(Panel removed for clarity)

Bed Operation

Initial Start Up

1. After positioning bed, always lock **all** casters. Bed should be allowed to reach room temperature before plugging power cord into grounded hospital-grade receptacle.

⚠ Caution: It is critically important to lock **all four** casters individually to prevent unintended bed movement.

Resident/Patient Transfer

1. **Lock** Casters and make sure mattress support platform is in non-extended position (narrow). Lower Side Rails and lower resident/patient in carefully controlled manner, onto bed.

⚠ Caution: It is critically important to lock **all four** casters individually to prevent unintended bed movement.

Emergency Manual Mattress Support Platform Release

1. The quickest way to flatten the mattress support platform is to use the Pendant or Staff Control.
2. To return mattress support platform to flat position in case of power and battery backup failure, rotate Emergency Manual Release lever **Up** (Figure 3). Hold Emergency Release handle **Up** until mattress support platform lowers to desired position. Release handle if you need to stop descent.

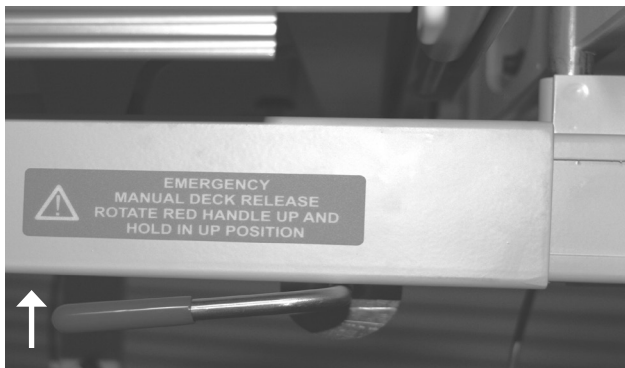

Figure 3

Pendant Control Operation

1. Your Bari10A bed comes standard with Pendant Control (Figure 4). Resident/patient and staff can use the Pendant to adjust all mattress support platform sections to desired positions.
2. Pendant has raised push buttons with graphics and may be hooked on rails or panels for convenient resident/patient and staff access.

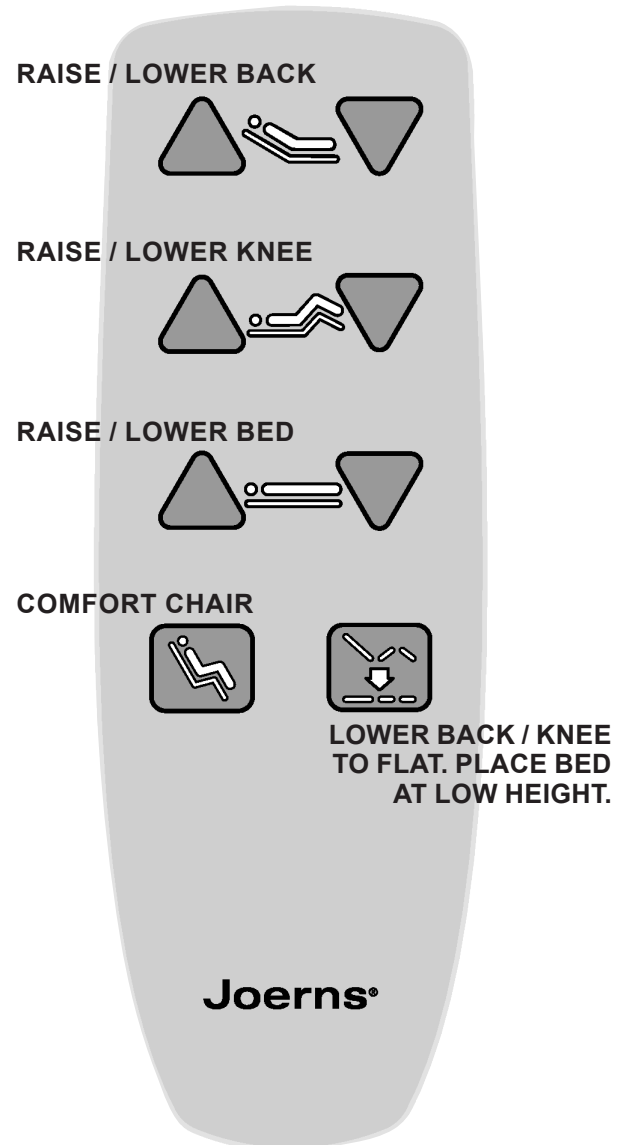

Figure 4

***Note:** As a safety feature the control system software will automatically lock out the knee down function when in a reverse Trendelenburg or comfort chair position. The function will unlock when the mattress support platform is returned to horizontal. This is done to keep the resident from sliding down in the bed.

Joerns® Bariatric Bed Frame Model Bari10A

Staff Control Panel Operation

The Staff Control panel allows caregiver to operate the bed from the foot panel without walking to the bedside (Figure 5). The caregiver can also individually lock out all functions on both the Pendant and Staff Control.

1. To lock out a function, press and hold “Lock” graphic on the panel and push the function to lock out. Illuminated amber LED indicates that function is now locked out.
2. To unlock function, press and hold “Lock” graphic on the panel and push the function to unlock. Amber LED is no longer illuminated, signaling that function is now operable.

⚠ Warning: Possible Injury Or Death. Use Staff Control to deactivate bed when resident/patient movement or inadvertent activation of bed functions by resident/patient or staff member could result in personal injury.



Figure 5

Side Rails/Assist Devices

1. Bari10A has one head end side rail and one foot end side rail on both sides of bed (Figure 7).
2. Side rails are locked and unlocked by a latch hinge mechanism.
3. Pull bottom of latch hinge outwards to lower side rails (Figure 8). **Note:** Latch hinge locks side rail only in **up** position.
4. Lower side rails gently.



Figure 7



Figure 8

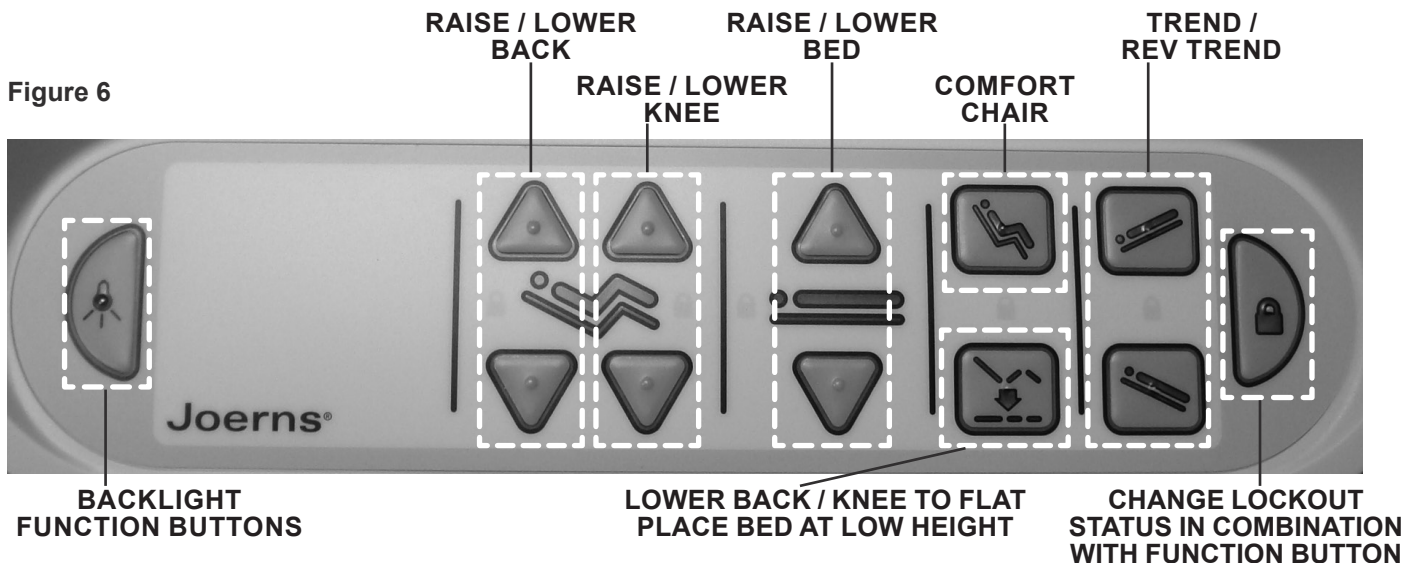

Figure 6

Casters

1. All (4) casters securely lock bed in place.
2. All casters have full swivel/rotation locking in any position.
3. Simply push Caster Lock lever (Figure 9) **down** to lock and **up** to unlock (Figure 10).

⚠ Caution: It is critically important to lock **all four** casters individually to prevent unintended bed movement.

Steer Wheel (optional) (Figure 11)

A bed equipped with this option has a steer wheel actuated by pedals on either side of the bed. The steer wheel helps in guiding the bed along a straight line and helps the bed pivot around corners.

Steer Wheel Operation (Figure 12)

To engage the steer wheel, fully depress the side of the pedal identified with a green label and represented by the ENGAGE green arrow. To disengage the steer wheel, fully depress the side of the pedal identified with a red label and represented by the DISENGAGE red arrow.

To avoid injury to the resident/patient and/or user, do not attempt to move the bed laterally with the steer mode engaged. The steer wheel cannot swivel.

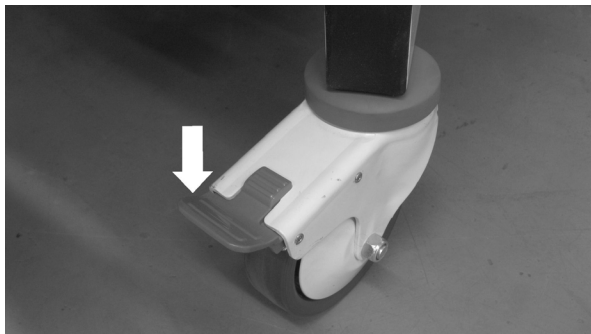

Figure 9

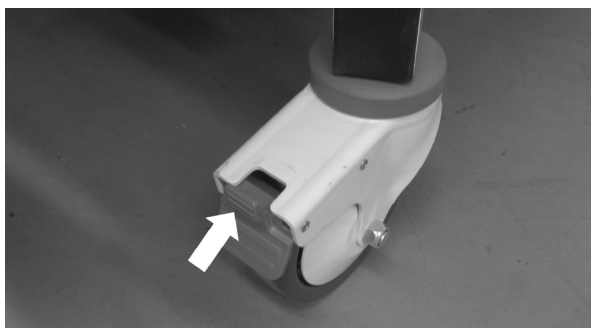

Figure 10

⚠ Warning: To reduce the risk of injury, ensure the mattress support platform is horizontal and in the lowest position with the siderails fully raised and locked when moving the bed with a resident/patient in it. For best maneuverability performance, push the bed from the head end.

⚠ Warning: Steer wheel must be disengaged to use scale.

⚠ Caution: To avoid damage to the siderail mechanisms, do not move the bed using the siderails. Use the push/pull handles integrated to the end panels to move the bed.



Figure 11

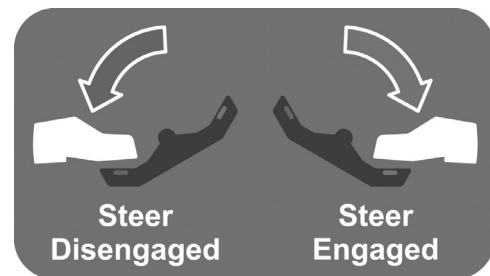

Left Side from foot of bed

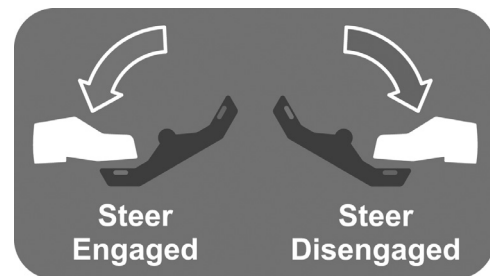

Right Side from foot of bed

Figure 12

Mattress Support Platform Width Extenders

1. The four mattress support platform (MSP) sections each have a 6" Width Extender on both sides. (Figure 13).
2. Release Width Extender by pulling latch handle along the bottom edge of each MSP section (Figure 14). **Note:** Width Extenders lock in either full open or full closed position and should **only** be used in these positions. Side rails move with the Width Extenders.

⚠ Caution: Extend all four sections on each side **prior** to adjusting bed position or side rails.

⚠ Warning: Use Width Extenders only after the resident/patient is safely positioned in the bed. Failure to do so could result in injury.

Mattress Support Platform Length Extender

1. Mattress support platform (MSP) foot section has an 8" Length Extender, as does the foot end of the bed frame (Figure 15).
2. Both MSP Length Extender and the Frame Length Extender lock in the retracted and extended positions.
3. Using the MSP Length Extender is a two-step process:
 - a. Slide the Frame Extender out first, by pulling out the latch knob on the side of the bed frame (Figure 15). Begin carefully sliding the extender out and release the latch knob as soon as the extender starts to slide, so that it will automatically latch again at the extended position. Slowly pull the extender out until the latch pin clicks into its detent.
 - b. Reach under the center of the MSP Foot Section and locate the MSP Extender latch knob (Figure 16). Pull the knob out to unlatch the Foot Section Extender. Begin carefully sliding the extender and release the latch knob as soon as the extender starts to slide so that it will automatically latch again at the extended position. Slowly pull the extender out until the latch pin clicks into its detent.

⚠ Warning: Possible Equipment Damage. Do not slide Frame Length Extender past its detent. Damage to the foot panel cables will result.

⚠ Warning: Possible Equipment Damage. Prior to use of the MSP Length Extender, the Frame Length Extender must be fully extended and latched. Failure to do so will result in foot panel connector damage.



Figure 13



Figure 14

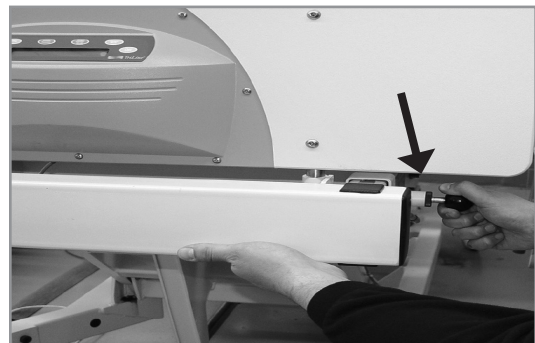

Figure 15 - Arrow indicates Length Extension Latch



Figure 16 - Photo taken from angle underneath bed

Bed Movement/Transport

1. Follow these general guidelines when moving bed (specific patient's needs may necessitate such requirements).
 - a. Fully lower all mattress support platform sections.
 - b. If extended, retract mattress support platform width extensions on both sides. **Note:** This may require removing mattress sections.
 - c. If extended, retract mattress support platform Foot extension.
 - d. Latch **all** side rails in **up** position.
 - e. **Required:** Place an attendant at each bed end.

⚠ Caution: Before transporting bed, unplug bed from power source, wrap power cord around cord storage hooks below head panel, hang Pendant from foot panel, and route Pendant cable inside Side Rails (Figure 17). Failure to do so could result in Pendant cable, power cord or bed damage, thereby creating a potential hazard. Ensure pendant cable and power cord are off floor and away from Casters.

- f. Unlock casters.
- g. Deploy Steer Wheel if equipped with optional steer pedal.
- h. Apply even push/pull force on head panel and/or foot panel handholds (Figure 18).
When bed movement/transport is completed:
 - Always apply caster locks and disengage steer wheel, if applicable.

⚠ Caution: It is critically important to lock all four casters individually to prevent unintended bed movement.

- Always plug bed back into power outlet so that it is continuously charging.

⚠ Caution: Steer Wheel must be disengaged to obtain an accurate resident/patient weight.

Accessories

Mattress

1. Bari10A Bed may be equipped with BariMatt 1000 6.5" foam mattress (Figure 19, p.12).
2. Mattress is designed as separate sections, which fit together on mattress support platform in different arrangements: narrow, sides extended, and/or length extended.

Important: Patient's risk for pressure ulceration determines which mattress should be used. Assessment of risk for pressure ulceration is important to avoid injury to patient, and should only be determined by qualified professionals.

Note: International standards require distance from top of mattress (un-compressed) to top of side rails to be a minimum of 220 mm (8.66 inches). If mattress is thicker than 6.5 inches (Example: If a professional recommends an air flotation system to treat pressure ulceration), bed/mattress system would not comply with International standards. A professional can assess if clinical benefits outweigh the risk of not meeting standards.

IV Sockets

The IV Sockets at the head and foot of the bed are rated for 50 lb. maximum vertical or 50 lbs-ft torque.

Drainage Bag Loops

Drainage Bag Loops are rated at 15 lb. maximum load.

⚠ Caution: Drainage Bag Loops are not intended for use as tie downs.

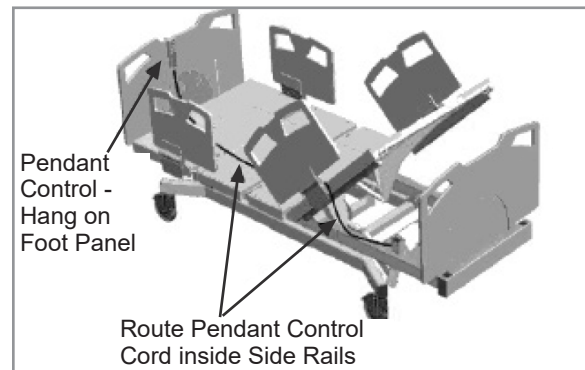

Figure 17



Figure 18

Joerns® Bariatric Bed Frame
Model Bari10A

Overall dimension of assembled mattress is approximately 48.5 x 89.5 x 6.5

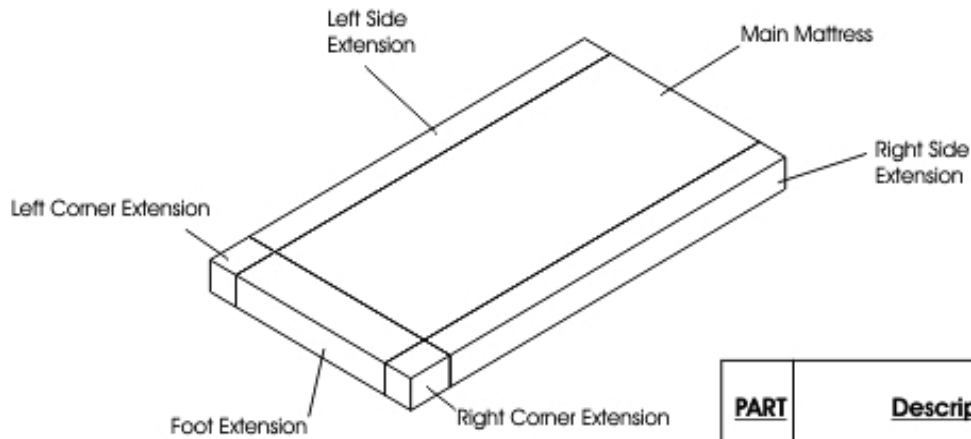

PART	Description	DIMENSION Inches
A	Main Mattress	36x81x6.5
B	Foot Extension	8x35.5x6.5
C	Right Side Extension	6x81x6.5
D	Left Side Extension	6x81x6.5
E	Right Corner Extension	6x8x6.5
F	Left Corner Extension	6x8x6.5

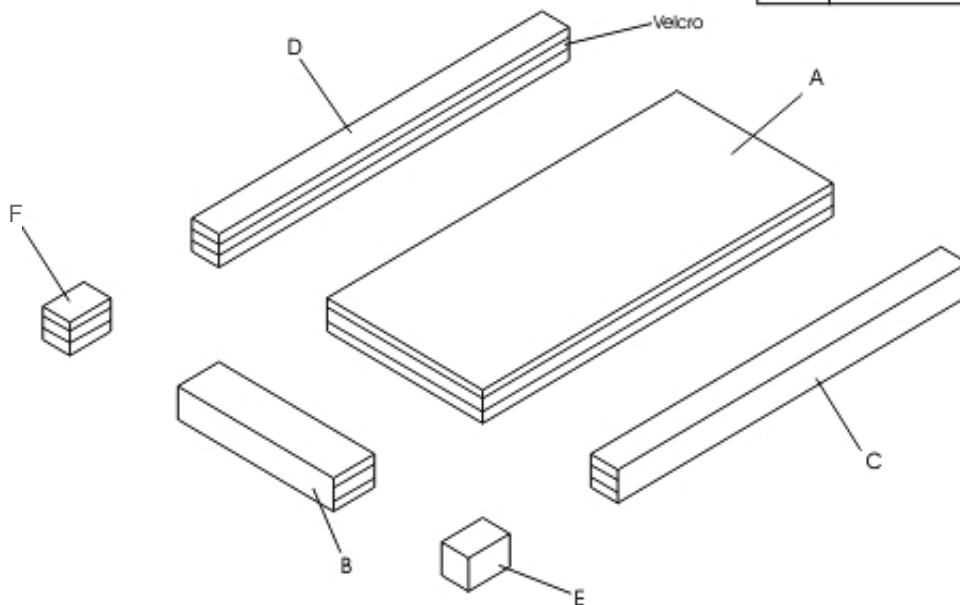

Figure 19

Scale System

Bari10A bed may be equipped with Scale System, fully integrated within foot panel (Figure 20).

Scale System Features (Figure 21)

1. Resident/patient's weight is displayed on a 16-character dot matrix liquid crystal display with LED backlighting.
2. Resident/patient's weight may be viewed in both **pounds** and **kilograms** by pushing **Weight Mode** button when weight is displayed. Weight is displayed with a resolution of 0.1 lb or Kg.
3. Monitor resident/patient's weight relative to **zero** by using **Weight Change Mode** button to observe variations in weight.
4. **Freeze/Resume** mode button provides ability to add or remove pillows, blankets or ancillary equipment, without affecting resident/patient's displayed weight.

Maximum Weight Capacity

Do not exceed rated safe working load capacity of bed (1050 pounds).

Scale Accuracy

0.5% of resident/patient weight or 0.5 lb, whichever is greater, from 250 to 1050 lbs, while bed is in flat position.

Auto Power Down (APD)

Scale System will automatically power down in 60 seconds to conserve battery life and protect resident/patient personal information.

Averaging

Automatic digital filter samples weight data to filter motion.

Power Supply

Powered by bed controller with integral battery backup.

Environmental Conditions

Operating Conditions

Ambient Temperature: +20°C to 30°C

Relative Humidity: 10% to 95% Non-Condensing

Storage and Shipping Conditions

Ambient Temperature: -30°C to +50°C

Relative Humidity: 10% to 95% Non-Condensing



Figure 20



Figure 21

⚠ Caution: Steer Wheel function must be disengaged to obtain an accurate resident/patient weight.

Scale System Functions and Weighing Procedures

⚠ Caution: Steer Wheel function must be disengaged to obtain an accurate resident/patient weight.

On

Button refreshes display or initiates power for scale use.

0.0 Zero

With all bed linens in place and without resident/patient in bed, press and hold **Zero** button. Displayed message will read "PLEASE WAIT - HANDS OFF". Be sure nothing touches weight-sensitive portion of integrated Scale System while performing zeroing function. In a few seconds, display will indicate "WEIGHT = 0.0 LB".

Lb/Kg

Weight data may be viewed in either **pounds** or **kilograms**. Pressing this button allows you to switch between display modes quickly and easily. Both modes will display resident/patient's weight within 0.1 units of resolution (0.1 Lb. or 0.1 Kg.).

Freeze/Resume

Freeze/Resume mode button provides ability to add or remove pillows, blankets or ancillary equipment, without affecting resident/patient's displayed weight.

Press **Freeze/Resume** button. The display will read "FREEZE = (resident/patient's weight)." Make all necessary adjustments to bed or resident/patient. When done, press **Freeze/Resume** button again to resume normal weighing.

Weight Change Mode

This mode is used to monitor resident/patient's weight changes. **Note:** To enable this function initially, press **Weight Change Mode** button with resident/patient in bed and then press **Zero** button to zero out weight. Display will read "WT CHG = (resident/patient weight)". Any variation in weight will now be viewed as a "+" or "-" figure relative to **zero**.

Weight Mode

If display shuts off before you can view weight data, simply press the **On** button to refresh display and view resident/patient's weight. Display will indicate "WEIGHT = XXX.X LB"(or KG).

⚠ Caution: After initialization process is complete and Scale System is still in **Weight Change Mode**, do not press **Zero** button **again**, or you will lose all stored resident/patient's weight history.

Pressing **Weight Mode** button will switch back to the **Weight Mode** allowing you to view resident/patient's total weight again.

⚠ Caution: If you **do not** press **Freeze/Resume** button before adding/removing items from bed, the weight of those items will be reflected in the displayed weight.

Note: You can correct any weight discrepancy described above, by using **Weight Mode** (for increases) and **Weight Change Mode** (for decreases) buttons, to manually adjust displayed weight reading. You will need to know the weight of added/removed items to add/subtract from total weight.

If **Freeze/Resume** mode is left unattended for more than three minutes, display will read "LEFT IN FREEZE - REFER TO MANUAL." You must press **Freeze/Resume** button to exit this mode.

Scale System Calibration

Periodic Calibration Check

1. **Important:** Following calibration procedure should only be performed by qualified maintenance personnel.
2. Load cell has no user serviceable components. **Do not** tamper with for any reason.
3. Re-calibration is generally not required, but should be verified periodically to ensure accuracy. Joerns Healthcare recommends checking calibration once every 12 months, or as your maintenance policy requires.

Calibration Procedure

Note: Make sure nothing is in contact with Scale System during this procedure. Be sure to remove your hands from Scale System when noting displayed calibration results.

1. Disengage Steer Wheel function if so equipped with optional steer pedal.
2. Press **Freeze/Resume** button.
3. When display indicates “FREEZE = (weight)”, press and hold **Lb/Kg** button. Display will read “CAL” as right hand digit counts down to enter CAL MODE.
4. When CAL MODE is shown, press **Zero** button to zero the display.
5. Place known calibrated weight onto weighing surface and compare it to displayed reading.
6. Press **Weight Mode** button for (+) corrections and **Weight Change Mode** button for (-) corrections to displayed weight. Displayed value should be within 0.5% of calibrated weight, plus or minus one digit.
7. Remove weight and re-zero. Repeat Steps 4-6, until results are satisfactory.
8. When adjustments are completed:
 - a. Press **on** button to **abort** your changes and exit the CAL mode, **(or)**
 - b. Press **Freeze** button to **save** all changes and exit CAL mode.

Calibration Tolerance Table

Low Limit	Applied Load (lbs)	High Limit
248.7	250	251.4
497.4	500	502.6
746.2	750	753.9
994.9	1000	1005.1

Scale System Care and Maintenance

Cleaning

1. Mild soap/water recommended for general cleaning/disinfecting.
2. Exercise caution when cleaning LCD window.

Electrostatic Discharge (ESD)

Integrated circuits and semiconductors on printed circuit boards may be damaged by electrostatic discharge (ESD). Be sure to use proper handling precautions at all times.

Electromagnetic Immunity

Electromagnetic Immunity is always relative and standards are based on anticipated environments of usage. If the user notes unusual device behavior, this could be an indication of electromagnetic interference. If such behavior is observed it may be associated with the nearby usage of radio or tv transmitters, cell phones, electro-surgical equipment, etc. and the user should try moving the interfering equipment further from this device.

Cleaning, Inspection and Maintenance

⚠ Warning: Disconnect Bari10A power cord from wall outlet before cleaning.

⚠ Warning: Do not use power wash or high pressure cleaner on **any** Bari10A part.

⚠ Warning: Lock all four casters when cleaning, inspecting or performing any maintenance of the Bari10A. Lower all mattress support platform sections unless necessary for service access. Lock all functions on Staff Control. Disconnect Power and Pendant cords.

⚠ Caution: It is critically important to lock **all four** casters individually.

Notice: Make sure the power cord is unplugged from the power outlet and the control unit battery is removed prior to disconnecting/connecting any foot panel cables. Failure to ensure bed is not powered when disconnecting/connecting the foot panel cables may result in damage to the bed's electronic controls.

1. To ensure maximum life of your Bari10A bed, follow all warnings and cautions within this manual and maintain your bed with care, as outlined below. The maintenance required will be dictated by your bed's usage and care, which should be inspected every six months.
2. To optimize bed longevity:
 - a. Keep bed clean.
 - b. Observe bed usage and operation and report any discrepancies or problems to Joerns Healthcare Technical Support at 800-966-6662.
 - c. Check for loose bolts, nuts or pins, and report problems. After a week of use, check all bolts for any looseness, and make sure all pins are in their normal location and fastened.
 - d. Check structural parts for any cracking (especially welds), bending or hole enlargement.
 - e. Check wiring for proper connections and damage (fraying, kinking or deterioration). Report any damage to Joerns Healthcare Technical Support at 800-966-6662.
 - f. Check actuators for correct mounting at attachment points and ensure all related pins are mounted securely and properly to frame. Actuators are not serviceable.

If any discrepancies are noted during inspection, they must be corrected before continuing bed use. Major service and repair must only be performed by authorized Joerns Healthcare Technical Support, which you may contact at 800-966-6662.

General Cleaning

1. For low level disinfecting, wipe surfaces with a properly prepared detergent/disinfectant.
2. Do not use abrasive cleaners. Use damp rag only, when cleaning around electrical connectors and components.
3. Actuator surfaces must be cleaned of dust and dirt regularly. Do not attempt to clean exposed actuator push tubes.

Storage

1. Store in a clean dry area.
2. Plug bed power cord into grounded hospital-grade electrical outlet. Backup batteries maintain the longest life if kept charged and are not allowed to fully discharge.
3. Failure to keep Bari10A bed plugged in, will discharge backup batteries and shorten their life.

Lubrication Servicing

Recommended Lubricants

1. **Lubricant:** Super Lube® Multi-Purpose Aerosol.
2. **Grease:** Use Super Lube® synthetic grease or equivalent.

Oiling Points

1. Keep pins and bolts oiled (sample indicated by arrows in Figure 22).
2. Oil hinge points (sample indicated by arrows in Figure 23).

Grease Points For Mattress Support Platform

1. Grease Side and Foot Extensions (sample indicated by arrows in Figure 24 and 25).

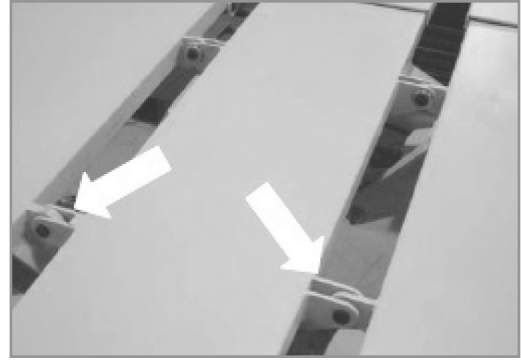

Figure 22

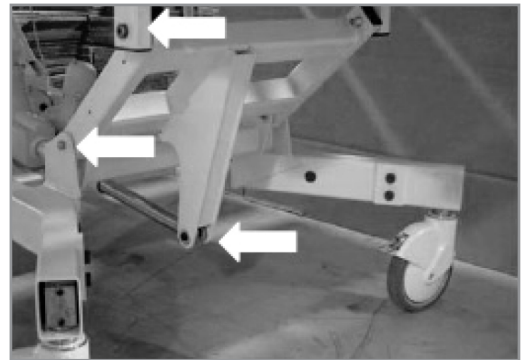

Figure 23

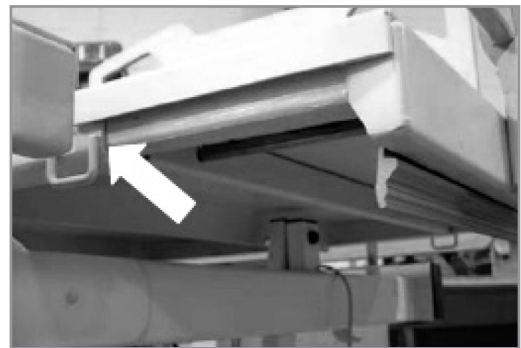

Figure 24

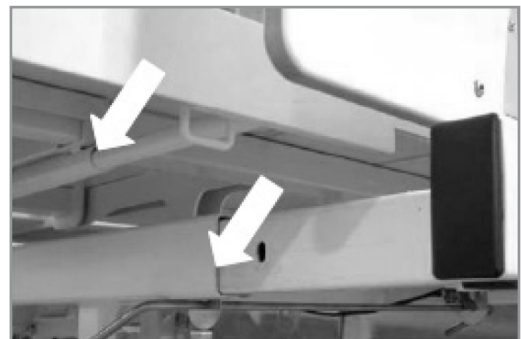

Figure 25

Bari10A Bed Troubleshooting

Pendant and Staff Control Troubleshooting

Problem	Solution
If movement does not occur when Pendant or Staff button is pushed	<ol style="list-style-type: none"> 1. Function may be locked. Check Staff Control function lockout. 2. Adjustment may already be at maximum or minimum level. 3. Bed is not plugged into wall power outlet and battery has discharged. Plug bed into wall outlet. 4. Pendant cord may be damaged. Check cord for damage. If cord is damaged, discontinue bed usage until cord is replaced.
If adjustment only partially occurs, stops and beeps	<ol style="list-style-type: none"> 1. Battery may be low. Plug bed into power source. 2. Bed may be overloaded or constrained from moving. Determine load and check for obstructions. 3. If beeping occurs while raising or lowering bed, Hi-Low actuators may have lost synchronization. Lower bed to lowest position. Release Bed Down button. Press and hold Bed Down button for five seconds to recalibrate synchronization. If problems persist, contact Joerns Healthcare Technical Support at 800-966-6662.
Bed not responding to staff control	<ol style="list-style-type: none"> 1. Check lockout status. 2. Check connection is fully inserted with cable secured. 3. Check the bed is plugged into power source and control box green light is illuminated. 4. Unplug bed for 60 seconds and plug back in. 5. If these steps fail to resolve the problem, call Technical Support at 800-966-6662.
All lockouts indicators flashing	<ol style="list-style-type: none"> 1. Push and hold Hi-Lo up and down on staff control or pendant simultaneously until flashing stops (No more than 15 seconds). 2. Unplug bed for 60 seconds and plug back in. 3. If these steps fail to resolve the problem, call Technical Support at 800-966-6662.
Knee Lockout indicator flashes when attempting articulation	<ol style="list-style-type: none"> 1. Bed is in a reverse Trendelenburg or Comfort Chair position, level bed. 2. Lower or raise Hi-Lo to end of travel. 3. If these steps fail to resolve the problem, call Technical Support at 800-966-6662.

Problem	Possible Cause	What to Do
Bed movement with all casters locked.	1. Braking mechanisms may be worn on one or more casters.	1. Remove bed from use and contact Joerns Healthcare Technical Support at 800-966-6662.
Scale System display is blank after On button is pushed.	1. Bed power cord may be unplugged and integral battery backup has become drained of power. 2. Unit is defective.	1. Plug in power cord. 2. Contact Joerns Healthcare Technical Support at 800-966-6662.
Scale System gives suspect readings.	1. Foot Panel cable connection is loose. 2. Scale System may need calibration. 3. Steer Wheel function is engaged.	1. Check for tight connection. 2. Refer to Page 15 of this Manual. 3. Disengage Steer Wheel function.
Mattress Support Platform sections do not extend.	1. Latch handles not fully disengaged. 2. Binding.	1. While actuating the latch handle, try to extend the mattress support platform extension. Refer to page 10 of this manual. 2. Wider support platform sections may require two hands to apply equal pull force. Contact Joerns Healthcare Technical Support at 800-966-6662.
Mattress Support Platform sections do not contour.	1. Pendant or Staff Control operation. 2. Staff Control function lockout may have been activated. 3. Unit may be defective or damaged.	1. Refer to Pendant or Staff Control Troubleshooting on page 18. 2. Refer to page 8 of this manual: Staff Control function lockout. 3. Remove bed from use and contact Joerns Healthcare Technical Support at 800-966-6662.
Actuator push tube will only move inwards and not outwards.	1. Unit may be defective or damaged. Possible synchronization problems.	1. Remove bed from use and contact Joerns Healthcare Technical Support at 800-966-6662.
Actuator motor makes sound, but push tube does not move.	1. Unit may be defective or damaged.	1. Remove bed from use and contact Joerns Healthcare Technical Support at 800-966-6662.
Actuator runs too slowly or does not give full power.	1. Bed may not be plugged in and is running on integrated battery backup with low charge. 2. Unit may be defective or damaged.	1. Plug in power cord and note any change in performance. 2. Remove bed from use and contact Joerns Healthcare Technical Support at 800-966-6662.

Appendix A - Actuator Wiring Diagram

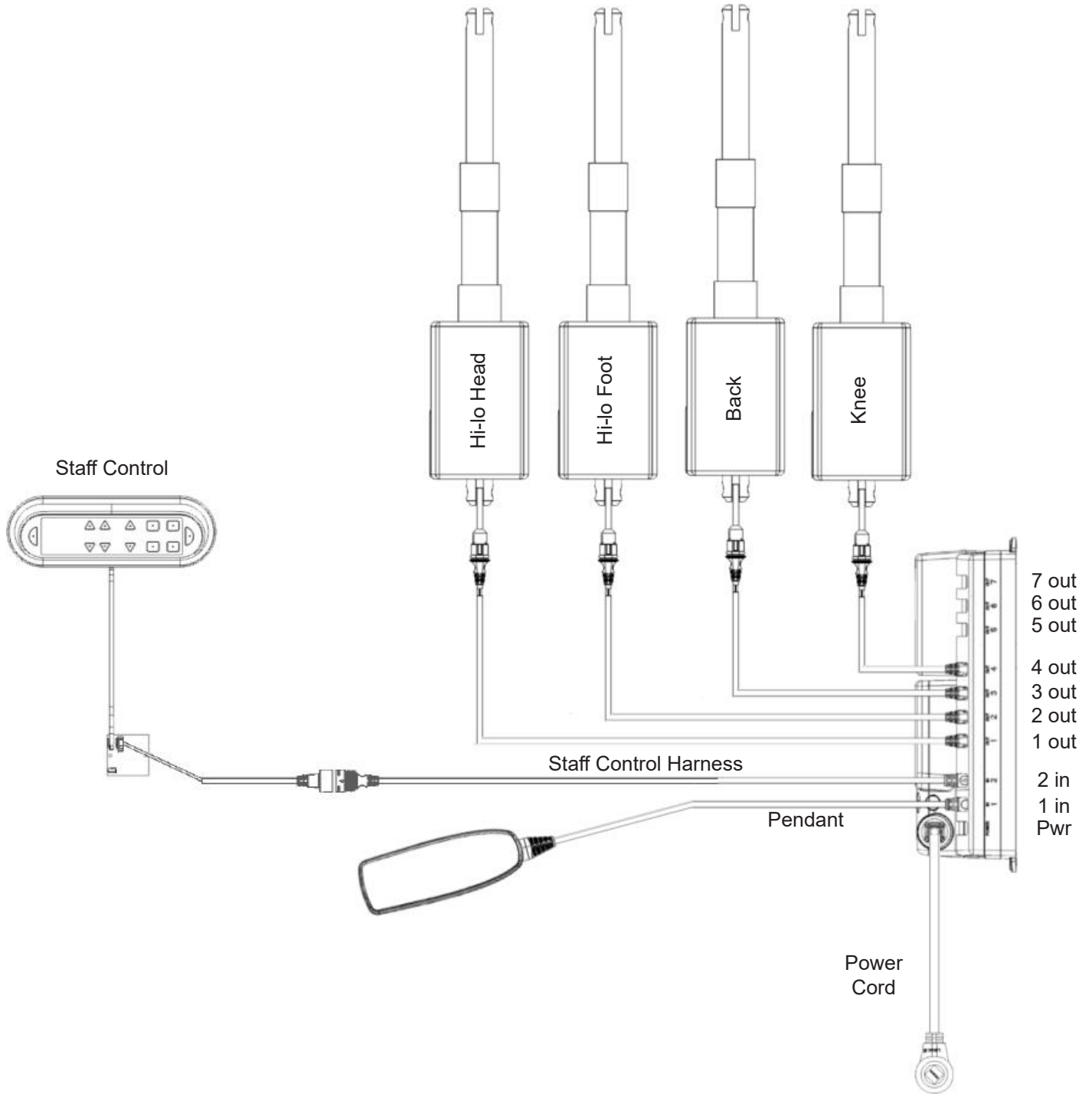

Appendix B – Scale System Wiring Diagram

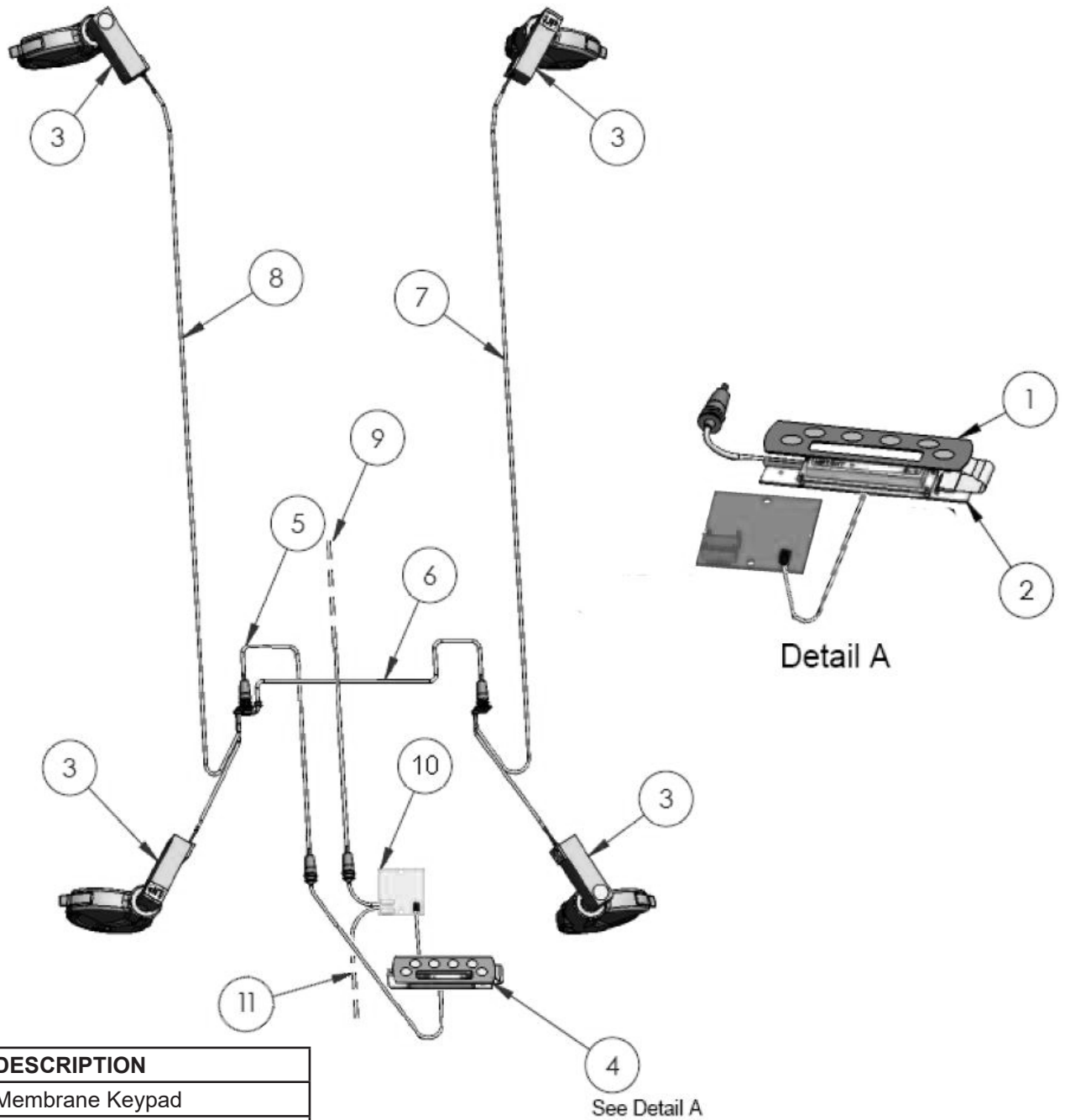

ITEM	DESCRIPTION
1	Membrane Keypad
2	Scale Display Board
3	Load Cell Assembly
4	Scale Display Assembly
5	Scale Harness
6	Foot End Load Cell Harness
7	Left Side Scale Harness
8	Right Side Scale Harness
9	Staff Control Harness
10	Power Conditioning Board
11	Staff Control Harness



Joerns Healthcare Warranty Program for Joerns® Bari10A Beds

Joerns® Bari10A beds are guaranteed for a period of one year from the date of delivery, against defects in materials and workmanship, under normal use and service.

This one-year warranty includes all mechanical and electrical components.

Steel structural components on beds are covered under warranty for a period of 10 years from the date of delivery.

Welds are covered under warranty¹ for the lifetime of the product.

Damage caused by use in unsuitable environmental conditions, abuse or failure to maintain the product in accordance with user and service instructions is not covered.

Any alteration, modification, or repair unless performed by or authorized in writing by Joerns Healthcare, will void this warranty.

Parts

Joerns beds contain various parts that wear from normal use. These parts, such as DC batteries, are not covered under the one-year warranty, but are covered for 90 days after date of delivery.

¹ Intended product lifetime is 15 years.
When device is determined to be disposed, consult local regulations to determine proper disposal method.

Joerns Healthcare's obligation under this warranty is limited to supplying replacement parts, servicing or replacing, at its option, any product which is found by Joerns Healthcare to be defective.

Warranty replacement parts are covered by the terms of this warranty until the product's original one-year warranty period expires.

When requested by Joerns Healthcare, parts must be returned for inspection at the customer's expense. Credit will be issued only after inspection.

Service

Most service requests can be handled by the facility Maintenance Department with assistance from the Joerns Healthcare Product Service Department.

Most parts requested can be shipped next day air at the customer's expense.

Should a technician be required, one will be provided by Joerns Healthcare, at our discretion. Only the Joerns Healthcare Product Service Department can dispatch authorized technicians.

This warranty is extended to the original purchaser of the equipment.

Manufactured By:

Joerns Healthcare LLC
2100 Design Rd. Ste 100
Arlington, TX 76014

Post Acute, Acute, HomeCare
2430 Whitehall Park Dr. Ste 100
Charlotte, NC 28273
(P) 800.826.0270
(F) 800.457.8827

VA/Government
19748 Dearborn Street
Chatsworth, CA 91311
(P) 800.966.6662
(F) 800.232.9796

Canadian Office
35 Consortium Court
London, ON Canada N6E 2S8
(P) 866.546.1151
(F) 519.451.8662

**United Kingdom and
Other Countries**
+44 (0)844 811 1156
+44 (0)844 811 1157

Netherlands
+31 (0)30 6363700
+31 (0)30 6363799